

# Connectors

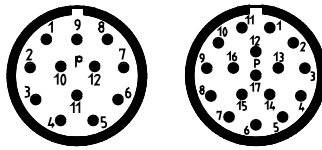

## M23 Standard (EML)



### Specification

#### Type M23

Number of contacts	12 or 17 pin
Protection class	IP 67 mated
Material	Housing: Zink, nickel plated Pins: Copper, gold plated



## 12 pole M23 (EML)

Part no. 1321968-01, 1321972-01

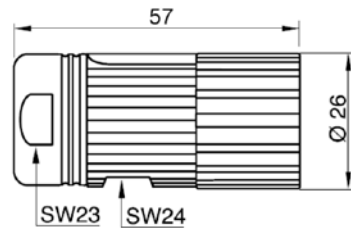
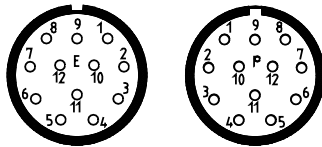

### Specification

#### 12 socket M23

#### Straight CW

Part no.	1321968-01
With assembled cable	2 m: Part no. 1320519-01 10 m: Part no. 1320519-02 Other lengths on request: Part no. 1320519-xx
Cable type	Shielded, PVC, (12x0.25 mm <sup>2</sup> )
Mating connector (CCW)	Part no. 1321970-01

#### 12 socket M23

#### Straight CCW

Part no.	1321972-01
With assembled cable	Other lengths on request: See next page
Cable type	Shielded, PVC, (5x2x0.25 mm <sup>2</sup> )

### Connection

#### 12 pole M23

#### Colour

1	White
2	Grey
3	Brown
4	Violet
5	Yellow
6	Black
7	Pink
8	Green
9	Grey/Pink
10	Blue
11	Blue/Red
12	Red

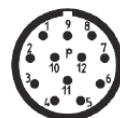
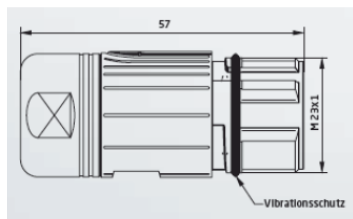

Pin layout

Mating Coupling 12 pin M23 CCW Part no. 1321970-01

# Connectors

## Specification

<b>12 socket M23</b>	<b>Straight CCW</b>
With assembled cable	Other lengths on request: Part no. 1320494-01
Cable type	Shielded, PVC, (5x2x0.25 mm <sup>2</sup> )
<b>Note: pin 2, 7 are not connected for other lengths on request.</b>	

## Connection

12 pole M23 Free length	Colour
1	White
2	NC
3	Brown
4	Violet
5	Yellow
6	Black
7	NC
8	Green
9	Grey
10	Blue
11	Pink
12	Red



Connection type: Soldered

## 17 pole M23

Part no. 1321966-01

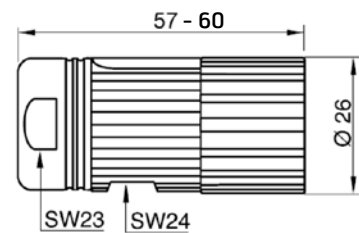
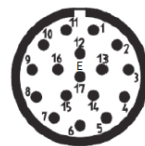
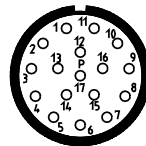

## Specification

<b>17 socket M23</b>	<b>Straight CCW</b>
Part no.	1321966-01
With assembled cable	2 m: Part no. 1320534-01 10 m: Part no. 1320534-02 Other lengths on request: Part no. 1320534-xx
Cable type	Shielded, PVC, (16x0.25 mm <sup>2</sup> )
Mating connector (CW)	Part no. 1321971-01

## Connection

17 pole M23	Colour
1	White
2	Grey/Pink
3	White/Green
4	Green
5	Pink
6	Grey
7	Red
8	Yellow
9	Black
10	Blue
11	NC
12	Green/Brown
13	Blue/Red
14	Violet
15	Yellow/Brown
16	Yellow/White
17	Brown

# Connectors



## MIL26482 Standard (PT)

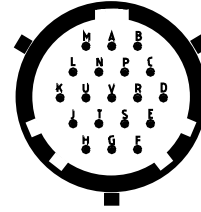
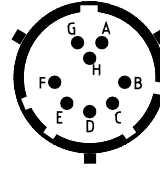
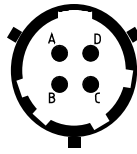

## Specification

### Type PT (MIL-26482)

Number of contacts	4, 8 or 19 pin
Protection class	IP 65
Material	Housing: Al, ROHS-compliant surface treatment Pins: Copper, gold plated

# Connectors



Connection type: Soldered

## MIL26482 8 socket (PT)

Part no. 1322207-01

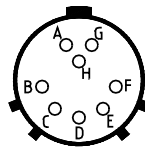

### Specification

8 pin PT	Straight
Connector	1322207-01
With assembled cable	2 m: Part no. 1320540-01 10 m: Part no. 1320540-02 1320540-xx
Cable type	Shielded, PVC, (5x2x0.25 mm <sup>2</sup> )
With shield termination available in cable gland.	
Connector with assembled cable may vary from drawing.	

### Connection

8 pole PT	Colour
A	Green
B	White
C	Black
D	Yellow
E	Red
F	Blue
G	Brown
H	Violet



Connection type: Soldered

## MIL26482 19 socket (PT)

Part no. 1256610-01

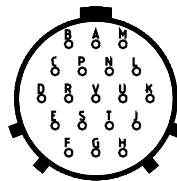

### Specification

19 socket PT	Straight
Connector	1256610-01
With assembled cable	2 m: Part no. 1238331-01 10 m: Part no. 1238331-02 1238331-xx
Cable type	Shielded, PVC, (16x0.25 mm <sup>2</sup> )
With shield termination available in cable gland.	
Connector with assembled cable may vary from drawing.	

### Connection

19 socket PT	Colour
A	White
B	Brown
C	Green
D	Yellow
E	Red
F	Blue
G	Grey
H	Pink
J	Black
K	Violet
L	Grey/Pink
M	Blue/Red
N	White/Green
P	Brown/Green
R	White/Grey
S	NC
T	NC
U	NC
V	White/Yellow

# Connectors

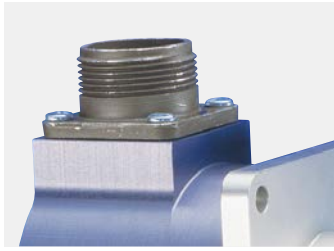

## 5015 Standard (MS)

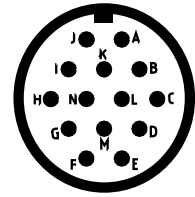
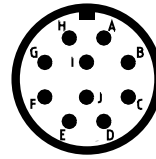
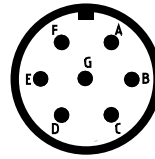
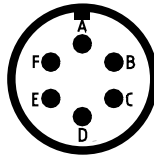

## Specification

### Type MS (MIL-5015)

Number of contacts	6, 7, 10 or 14 pin
Protection class	IP 65
Material	Housing: Al Pins: Copper, gold plated

# Connectors



## 5015 6 socket (MS)

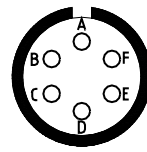

### Specification

6 socket MS	Straight	Angled	Cable gland
Connector	1337916-01	1109875-01	Ø8-11 mm
	1337916-02	1109875-02	Ø11-14 mm

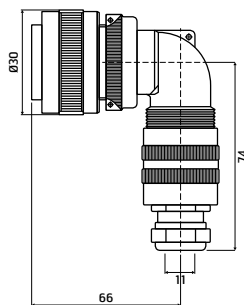
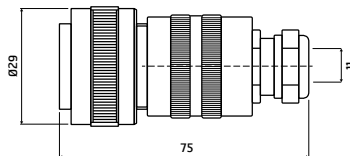

### Connection

6 pole MS	Colour
A	Green
B	White
C	Black
D	Yellow
E	Red
F	Blue

#### 6 socket MS connector

With assembled cable	Straight
2 m. Part no.:	1320548-01
10 m. Part no.:	1320548-02
Other lengths on request:	1320548-XX
Cable type:	Shielded, PVC, (5x2x0.25 mm <sup>2</sup> )

With shield termination available in cable gland.

Connector with assembled cable may vary from drawing.

#### 6 socket MS connector

With assembled cable:	Angled
2 m. Part no.:	1321077-01
10 m. Part no.:	1321077-02
Other lengths on request:	1321077-XX
Cable type:	Shielded, PVC, (5x2x0.25 mm <sup>2</sup> )

With shield termination available in cable gland.

Connector with assembled cable may vary from drawing.

# Connectors



## 5015 7 socket (MS)

Part no. 1322220-01, 1322321-01

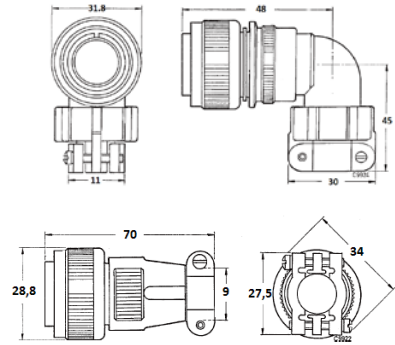
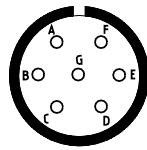

## Specification

7 socket MS	Straight	Angled
Connector, Part no.	1322220-01	1322321-01
With assembled cable:		
2 m, Part no.	1322315-01	1322319-01
10 m, Part no.	1322315-02	1322319-02
Other lengths on request, Part no.	1322315-XX	1322319-XX
Cable type	Shielded, PVC, (5x2x0.25 mm <sup>2</sup> )	

Connector with assembled cable may vary from drawing.

## Connection

7 pole MS	Colour
A	Green
B	Yellow
C	Red
D	Violet
E	Black
F	White
G	Blue

# Connectors



## 5015 10 socket (MS)

Part no. 1102133-01, 1102133-02

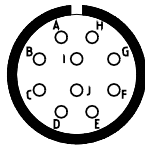

### Specification

10 pin MS	Straight	Angled	Cable gland
Connector	1110488-01	1102133-01	Ø8-11 mm
	1110488-02	1102133-02	Ø11-14 mm

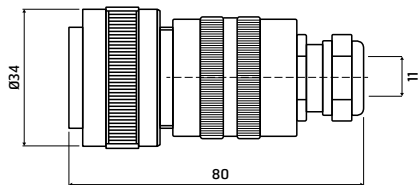

### Connection

10 pole MS	Colour
A	Green
B	White
C	Black
D	Yellow
E	Red
F	Blue
G	Brown
H	Violet
I	Grey
J	Pink

### 10 socket MS connector

With assembled cable:	Straight	Angled
2 m. Part no.:	1321201-01	1321080-01
10 m. Part no.:	1321201-02	1321080-02
Other lengths on request:	1321201-XX	
Cable type:	Shielded, PVC, (5x2x0.25 mm <sup>2</sup> )	

With shield termination available in cable gland.

Connector with assembled cable may vary from drawing.

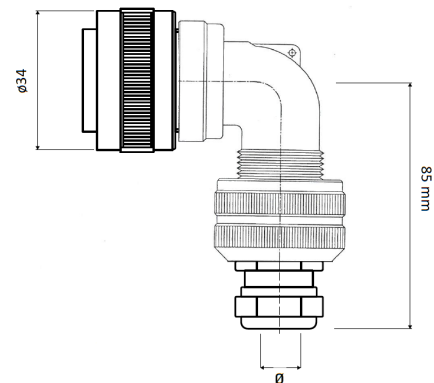

# Connectors



## 5015 14 socket (MS)

Part no. 1322209-01,  
1322216-01

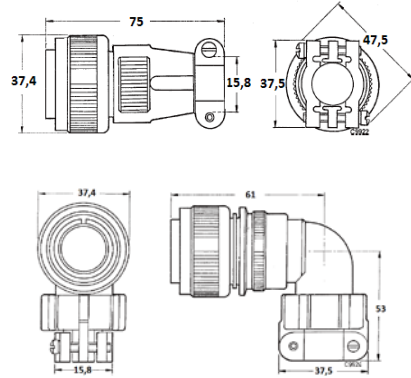
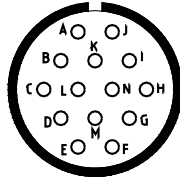

## Specification

14 socket MS	Straight	Angled
Connector, Part no.	1322209-01	1322216-01
With assembled cable:		
2 m, Part no.	1322316-01	1322318-01
10 m, Part no.	1322316-02	1322318-02
Other lengths on request, Part no.	1322316-xx	1322318-xx
Cable type	Shielded, PVC, (16x0.25 mm <sup>2</sup> )	

Connector with assembled cable may vary from drawing.

## Connection

14 pole MS	Colour
A	White
B	Brown
C	Green
D	Yellow
E	Red
F	Blue
G	Grey
H	Pink
I	Black
J	Violet
K	Grey/Pink
L	Blue/Red
M	White/Green
N	White/Yellow

# Connectors



## M12 Standard

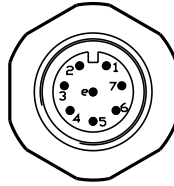

### Specification

Type M12	A-coded
Number of contacts	8 pin
Protection class	IP 67
Material	Housing: Brass, nickel-plated or zink alloy, nickel-plated Pins: Brass, gold plated



Connection type: Screw

## 8 socket M12

Part no. 586299-05

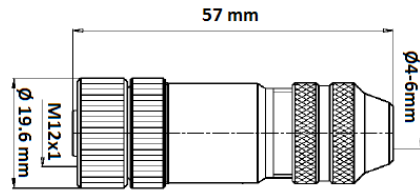

Part no. 586299-05



### Specification

8 socket M12	A-coded
Part no.	586299-05
With assembled cable:	2 m: Part no. 586238-03 5 m: Part no. 586238-04
Other lengths on request, Part no.	1320491-xx
Cable type	Shielded, TPE/PUR, 8x0.25 mm <sup>2</sup>

Connector with assembled cable may vary from drawing.

### Connection

8 pole M12	Colour
1	White
2	Brown
3	Green
4	Yellow
5	Grey
6	Pink
7	Blue
8	Red

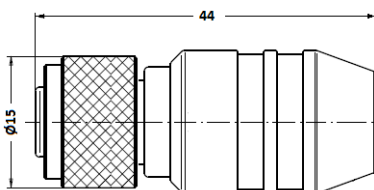
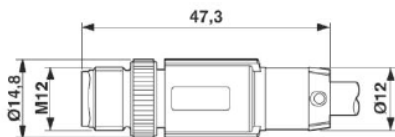

# Connectors



## 4 and 5 pin M12

Power supply, CANopen, PROFIBUS, PROFINET, DeviceNet, EnDat, EtherCAT, EtherNet/IP, Drive-CLiQ



### Specification Power supply

4 pole M12	A-coded
Connector, Part no.	586299-02
With assembled cable:	
Connector-Open 5 m, Part no.	586238-01
Cable type	Shielded, PUR, 4x0.34 mm <sup>2</sup>

### Connection

4 pole M12	Colour
1	Brown
2	White
3	Blue
4	Black

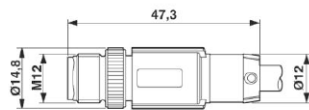

Assembled cable coupling

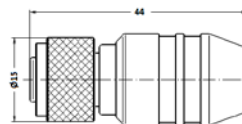

Assembled cable connector

Connection type: Screw

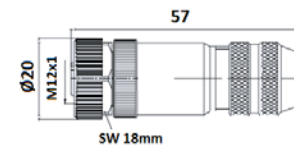

Part no. 586299-02

### Specification CANopen, DeviceNet

5 pole M12	A-coded
Coupling, Part no.	586293-01
Connector, Part no.	586299-01
With assembled cable:	
Coupling-Connector 5 m, Part no.	584409-01
Coupling-Open 5 m, Part no.	584412-01
Connector-Open 5 m, Part no.	584417-01
Cable type	Shielded, PUR, 4x0.34 mm <sup>2</sup>
Terminating resistor, Coupling	586276-01

### Connection

5 pole M12	Colour
1	Bare
2	Red
3	Black
4	White
5	Blue

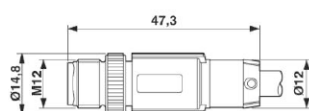

Assembled cable coupling

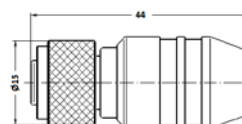

Assembled cable connector

Connection type: Screw

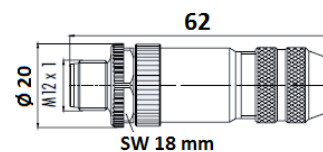

Part no. 586293-01

# Connectors

## Specification PROFIBUS

5 pole M12	B-coded
Coupling, Part no.	586281-01
Connector, Part no.	586287-01
With assembled cable:	
Coupling-Connector, Part no.	584387-01*
Coupling-Open 5 m, Part no.	584398-01
Connector-Open 5 m, Part no.	584401-01
Cable type	Shielded, PUR, 4x0.34 mm <sup>2</sup>
Terminating resistor, Coupling	584217-01
T-coupling	629025-01

## Connection

5 pole M12	Colour
1	-
2	Green (A-line)
3	-
4	Red (B-line)
5	-

Connection type: Screw

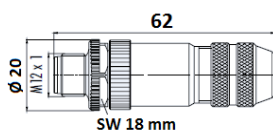

Part no. 586281-01

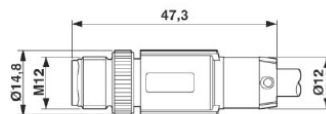

Assembled cable coupling

Part no. 584398-01  
\*Part no. 584387-01

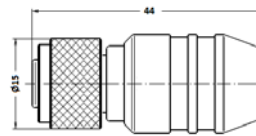

Assembled cable connector

Part no. 584401-01  
\*Part no. 584387-01



Part no. 584217-01

## Specification PROFINET, EtherNet/IP, EtherCAT

4 pole M12	D-coded	Connection method
Coupling, Part no.	586243-01	Screw connection
Coupling, Part no.	1426925-01	Insulation Displacement Connector
With assembled cable:		
Coupling-Coupling 5 m, Part no.	584404-01	
Cable type	Shielded, PUR, 4x0.34 mm <sup>2</sup>	
Adapter M12 4p, Connector to RJ 45, angled	586271-01	

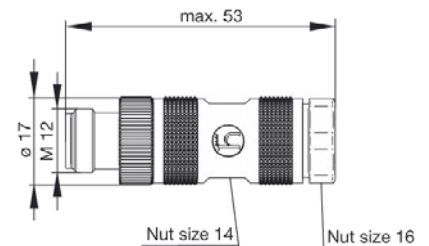

Part no. 586243-01

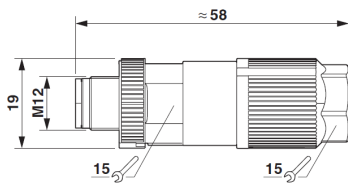

Part no. 1426925-01

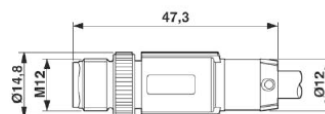

Assembled cable coupling

Part no. 584404-01

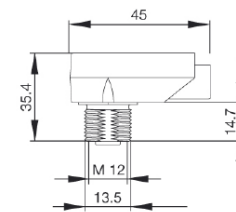

Part no. 586271-01

## Pre-assembled Drive-CLiQ

Drive CLiQ	Part no.
6 meters	1099056-01
15 meters	1099056-02
Cable type	Shielded, PVC, 4x0.34 mm <sup>2</sup>

## PROFINET/PROFIsafe, EtherNet/IP cable

Length	Part no.
2 meters	1475517-01
5 meters	1475517-02
10 meters	1475517-03
1-100 meters (on request)	1475517-XX
Shielded, PUR, 4x0.34 mm <sup>2</sup> , Cat 5, outer cable diameter: 6.5 mm	

# Connectors

## ADS

Cable M12 - RJ45	Part no.
2 meters ADS Online	800480-01
Cable type	Shielded, PUR, 4x0.34 mm <sup>2</sup>
ADS Classic - PC diagnostic back cover	1041978-01



## Specification SSI

12 socket M23	Straight CCW
Connector-Open, 8 m Part no.	1135222-01
Connector-Open 10 m, Part no.	1135222-02
17 socket M23 (900 Series)	Straight CCW
Connector-Open, 2 m Part no.	1117967-01
Connector-Open 10 m, Part no.	1117967-02
Cable type	Shielded, TPE/PUR, 3x4x0,24+1x4x0,24 mm <sup>2</sup>
17 pole M23 (600 Series)	Straight CCW
See 17 pole M23 on page 2	

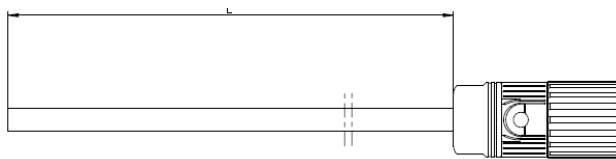

12 Socket M23

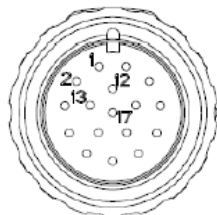

17 Socket M23

## Connection 1135222-01,02

12 pole M23	Colour
1	Brown/Green
2	White/Green
3	Violet
4	Grey
5	Green
6	Pink
7	Yellow
8	Red/Black
9	Black
10	Yellow/Black
11	Green/Black
12	Blue/Black

## Connection 1117967-01,02

17 pole M23	Colour
1	Blue
2	Black
3	Brown
4	White
5	Green
6	Red
7	Brown/Green
8	Violet
9	Yellow
10	White/Green
11	NC
12	Blue/Black
13	Red/Black
14	Grey
15	Green/Black
16	Yellow/Black
17	Pink

# Connectors

## Specification EnDat

<b>17 socket M23</b>	<b>Straight CCW</b>
Connector-open 2 m, part no.	1117975-01
Connector-open 10 m, part no.	1117975-02
Cable type	Shielded, TPE/PUR, 3x4x0,24+1x4x0,24 mm <sup>2</sup>

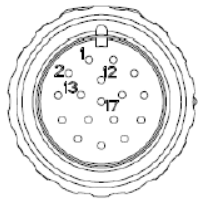
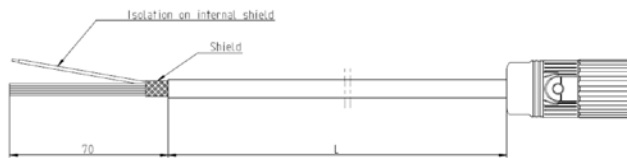

17 Socket M23

## Connection

17 pole M23	Colour
1	Blue
2	NC
3	NC
4	White
5	NC
6	NC
7	Brown/Green
8	Violet
9	Yellow
10	White/Green
11	NC
12	Blue/Black
13	Red/Black
14	Grey
15	Green/Black
16	Yellow/Black
17	Pink

# Cables and Caps



## Additional accessories

Cables



## Specification

Part number	Wire configuration	Material	Temperature range static installation	Outer cable dimension
1320490-XX	5x2x0.25 mm <sup>2</sup>	PVC	-30°C/+80°C	7.9 +- 0,2 mm
1319768-XX	12x0.25 mm <sup>2</sup>	PVC	-40°C/+80°C	7,7 mm
1320492-XX	8x0.25 mm <sup>2</sup>	TPE/PUR	-40°C/+90°C	5,7 +- 0,2 mm
1320495-XX	5x2x0.25 mm <sup>2</sup>	TPE/PUR	-40°C/+100°C	7,9 mm
1322311-01	5x2x0.5+1x1.53 mm <sup>2</sup>	HFS	-40°C/+95°C	12,0 mm
1185345-XX	3x4x0,24+1x4x0,24 mm <sup>2</sup>	TPE/PUR	-40°C/+100°C	8,9 mm

## Protective caps

M12	Part no.
For connector with holder	817013-01
For connector	817013-03
Filler Plug	508928-05
Dust protection coupling	204207-24



Connector with holder: 817013-01



Filler Plug: 508928-05



Dust protection: 204207-24



Connector: 817013-03